

INSTALLATION GUIDE
ARENA | STUDIO | ORIGINAL | MAX

Step 07

Finishing + Surrounds

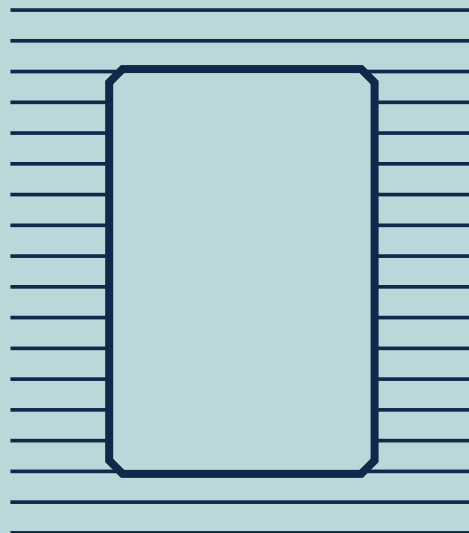

Our 8 step process to installing your Plungie

[Click here](#) to access the complete Plungie Install Guide.

Alternatively, you can click on any of the 8 icons below, each representing a specific step in the installation process.

Clicking on an icon will take you directly to the corresponding guide, allowing you to access the information you need quickly and easily.



Choose Plungie



Building Approval



Site Preparation



Crane Hire



Electrical + Backfill

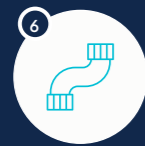

Plumb Up



Finishings + Surrounds



Fill + Start Up

This information is offered as a general guide only, and specific advice should always be sought by engaging with an engineer before undertaking any installations specific to your site.

Whilst Plungie Pty Ltd has made every effort to ensure the accuracy and effectiveness of this information, we make no representation as to the accuracy or effectiveness of the information and take no responsibility for any loss, damage or injury which may be caused as a direct or indirect result of the use of this information.

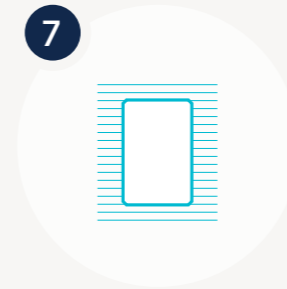

Step 07 Finishing + Surrounds

- WATERLINE TILES (OPTIONAL)
- COPING TILE
- DECKING / PAVING / SURROUNDS
- LANDSCAPING
- POOL FENCING CERTIFICATION

The content provided in this guide is part of an 8 step process extracted from the [Plungie Install Guide](#)

This guide is intended to provide you with a brief overview of this step, within our 8 step process. However, it's important to note that this excerpt should be read in conjunction with our more detailed guide and engineering set.

The more detailed guide and engineering set contain critical information that will help ensure a successful installation, and we highly recommend that you refer to them throughout the process.

By doing so, you'll have access to all the necessary information, including installation diagrams, specifications, and step-by-step instructions.

So, let's get started!



This guide is continually updated, please ensure you are accessing it via the link provided to ensure you are viewing the latest copy.

Step 7

Finishing + Surrounds

Finishing and surrounds	59
Landscaping and tiling	59
What are ferrules?	60
Ferrules - Doweling into your surrounds	60
Ferrules - Glass Balustrade Fencing	61
Requirements Glass Balustrade Fencing	62
Tiling Guide	67

GET READY TO...

- Tile (Optional)
- Coping tiles
- Pool surrounds - decking / paving
- Fencing
- Landscaping
- Pool fencing certification

Finishing and surrounds

If your Plungie is being installed in-ground or semi-recessed, the over-excavated area of the footing will need to be backfilled with a granular material that allows for drainage away from the footings.



Fencing:

Do not fill your Plungie until you have been issued with final fencing barrier inspection certificate. Water safety is a serious issue and fencing your Plungie is a requirement by law, therefore, ensure you use an accredited safety fence inspector.

When purchasing a Plungie without our standard ecoFinish internal coating as a 'blank shell' or with a waterline tile provision, the Plungie will require waterproofing on-site before the internal tile finish can be carried out.

We recommend engaging a trade qualified tiler, who has experience waterproofing and tiling concrete pools, as this is a critical step in finishing the internal of the Plungie.

LANDSCAPING AND TILING

There is a high risk of damage to your pool during the construction phase, whilst tiling, fencing, landscaping and plumbing. Any damage caused may impact or void your pool warranty, so ensure all trades are aware of the associated risks and that considerations are in place before works begin.



Concrete pools may contain Respirable Crystalline Silica (RCS), which can be generated and released into the air during tasks that involve high-energy processing, such as cutting, sawing, grinding, drilling, scabbling, and crushing. As per compliance with the WHS Regulations, and to maintain the warranty, customers must refrain from modifying or altering the concrete pool.

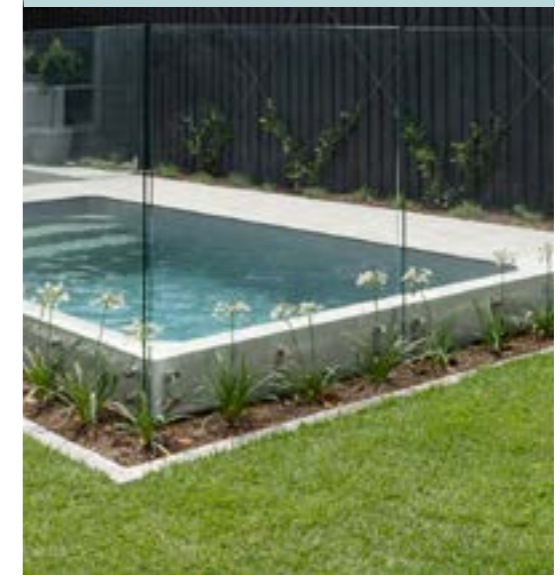

WHAT ARE FERRULES?

The purpose of ferrules are to allow customers to utilise the shell of their Plungie to directly attach glass balustrade fencing or alternatively dowel into or deck around their surrounds.

Ferrules are provisions added to the pool shell to enable glass balustrade fencing to be attached to the pool or alternative to dowel into the sides of pool, which can then in turn be used to secure the concrete surrounds to the pool.

Ferrules are an option on the Arena pools for dowelling into the surrounds purposes only and not for attaching glass balustrades.

This must be included at time of order as they cannot be retrofitted.



Correct use of ferrules:

Ferrules are not to be used for tying independent structures which could induce additional bending stresses in the pool shell walls.

Refer to [+ Engineering Set](#) for structural guidelines and drawings related to ferrules.

Only glass attached to our factory installed ferrules will ensure compliance with warranty terms and conditions. Pools that have been drilled or modified outside of the factory for the purpose of attaching glass will be void of all Plungie warranties.

Decking or Doweling into your surrounds

Surrounding slabs should be connected to your pool through a doweling system. As per our engineering, you can dowel into your surrounds via ferrules which are an optional inclusion within the pool shell.

A timber deck can also be fitted to the pool shell. Refer to the Plungie Engineering Set for detailed information.

PRODUCT DETAILS AND SUPPLIERS

Threaded Bar N12 x 600mm

Supplier: Actech

Part Number: 5THRB12-60N

- The above product is a 12mm threaded rod, this can also be purchased from Bunnings or an alternative supplier.

Chino Dowelsert 16mm Dry

Supplier: FormDirect

Part Number: DS16600NS



Skimmer Box Concrete Surround Requirements

Prior to pouring the surrounds, make sure to incorporate a flex or boxing around the skimmer box.

This prevents potential cracking of the skimmer box unit due to concrete expansion or contraction.

Utilise ferrules on either side of skimmer box for rebar support.

[Refer to Poolrite Innoskim User Manual](#)



Things to note - Doweling into surrounds'

- Only apply this detail if concrete apron is required for the specific site
- Concrete apron is to be detailed to ensure it will not induce any additional bending stresses in the pool shell walls
- If an alternative joint / apron detail is proposed, it will need to be assessed by a local certified structural engineer
- Ferrules are not to be used for fixing independent structures



Things to note - Decking

- The requirements of the ABA
- If the deck should be designed and certified by a structural engineer.
- How frequently the deck should be inspected and by whom.
- Using stainless steel for all metal components.
- Using minimum F17 kiln dried durability class 1 hardwood.
- How the deck is braced
- Termite and bushfire considerations.
- Using a malleable flashing between timber structure and the decking (e.g. Malthoid)



Glass Balustrade Fencing

The information provided in this guide is to assist with the ordering and installation process for glass balustrade fencing. The installation of such fencing should be undertaken by a professional and in accordance with any instructions provided by your glass provider.

Only the glass balustrade outlined in this guide is compliant and all other attachments to the shell may void the 10 Year Plungie Warranty.

By following the guidelines in this document the end result of the glass balustrade fencing will be;

- Maximum 50mm gaps between panels on the side of the pool.
- Approximately a 70mm gap between on corners where glass panels meet.
- Maximum 25mm gaps between a corner glass panel and the corner of the pool.
- 1.26m high barrier to the pool on all edges the glass balustrade fencing is installed. This allows for a maximum 60mm coping to still deliver a 1.2m high barrier.

ORDERING

We recommend contacting Trade Glass Depot when ordering your glass and standoffs.

Trade Glass Depot operate independently of Plungie but have experience working with our product and understand the technical requirements. Trade Glass Depot deliver Australia wide and can provide all equipment required.

Refer to the following pages which detail the panel requirements for each Plungie model.

TRADE GLASS DEPOT

Phone: 1300 889 375

Email: info@tradeglassdepot.com.au

57 Yarraman Place
Virginia, Queensland, 4014

tradeglassdepot.com.au

Glass panel requirements

- 12mm Toughened Glass
- R5 Corners
- Ø 20mm holes for attachment
- For all panel size options (refer to Panel Requirements), outer mounting holes are 100mm from edge of the glass. This ensures a 50mm gap between panels and 25mm gap on the edge of the pool.
- Bottom mounting holes are 50mm from lower edge of glass.
- A panel height of 1460mm is recommended to deliver a 1260mm barrier from the top edge of the pool. A coping tile of no more than 60mm high can be added to the pool to maintain a minimum 1200mm high barrier. Panels of a shorter height may be used in accordance with your local regulatory requirements.

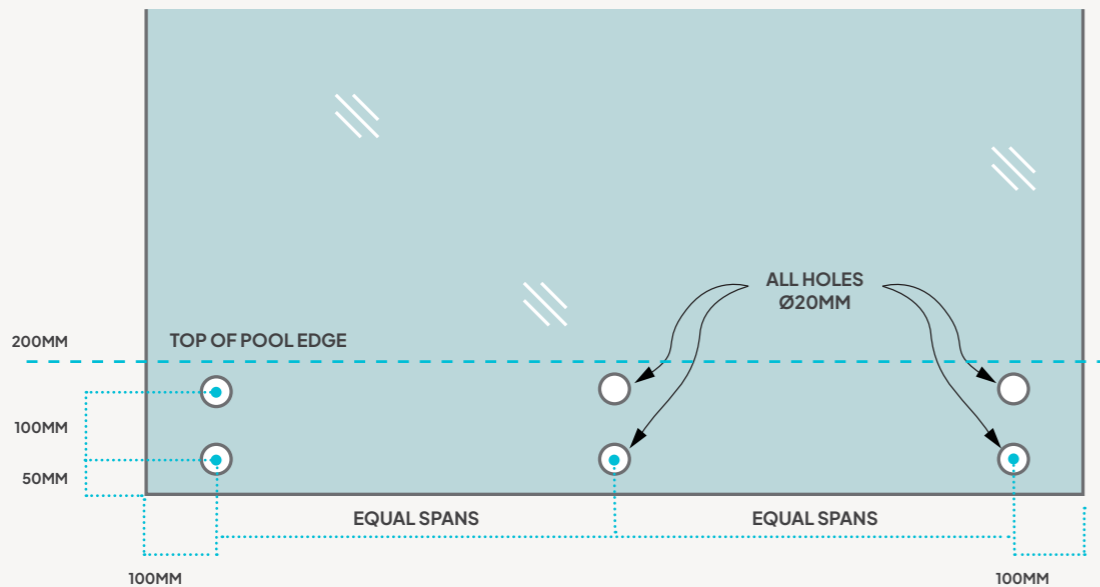

Mounting requirements

- Use M12 x 25mm mounting pins.
- Do not over-tighten mounting pins. Use a torque wrench set to 57Nm.
- Maximum depth of internal thread is 24mm.
- Earthing is not required for mounting pins.



Things to note

- The side walls of all Plungie's taper. To accommodate for this and ensure the glass panels remain upright, a **1.5mm spacer is required on the bottom mounting pin only**. Some adjustment may be required on site to achieve a

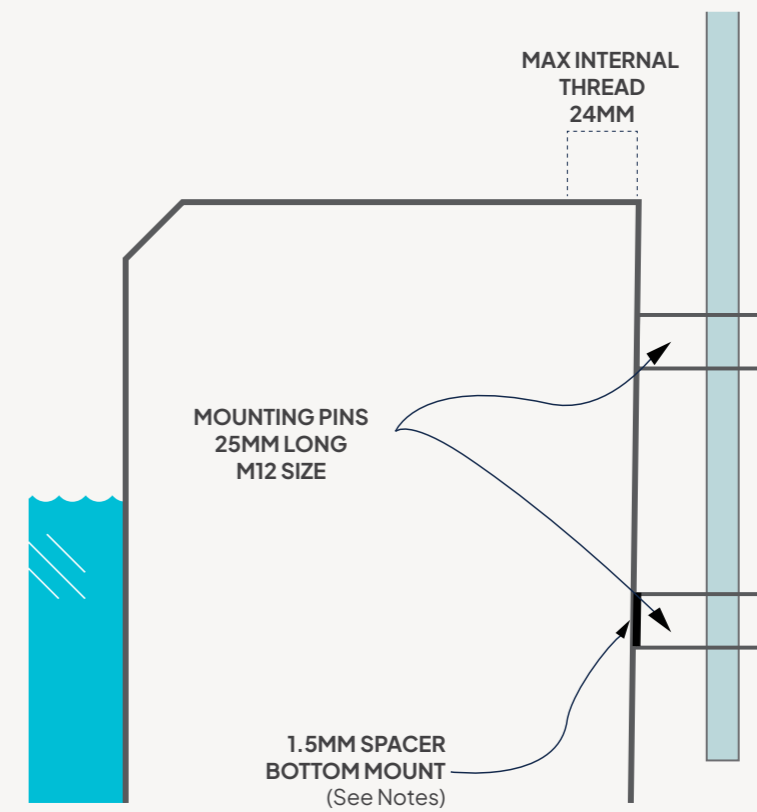

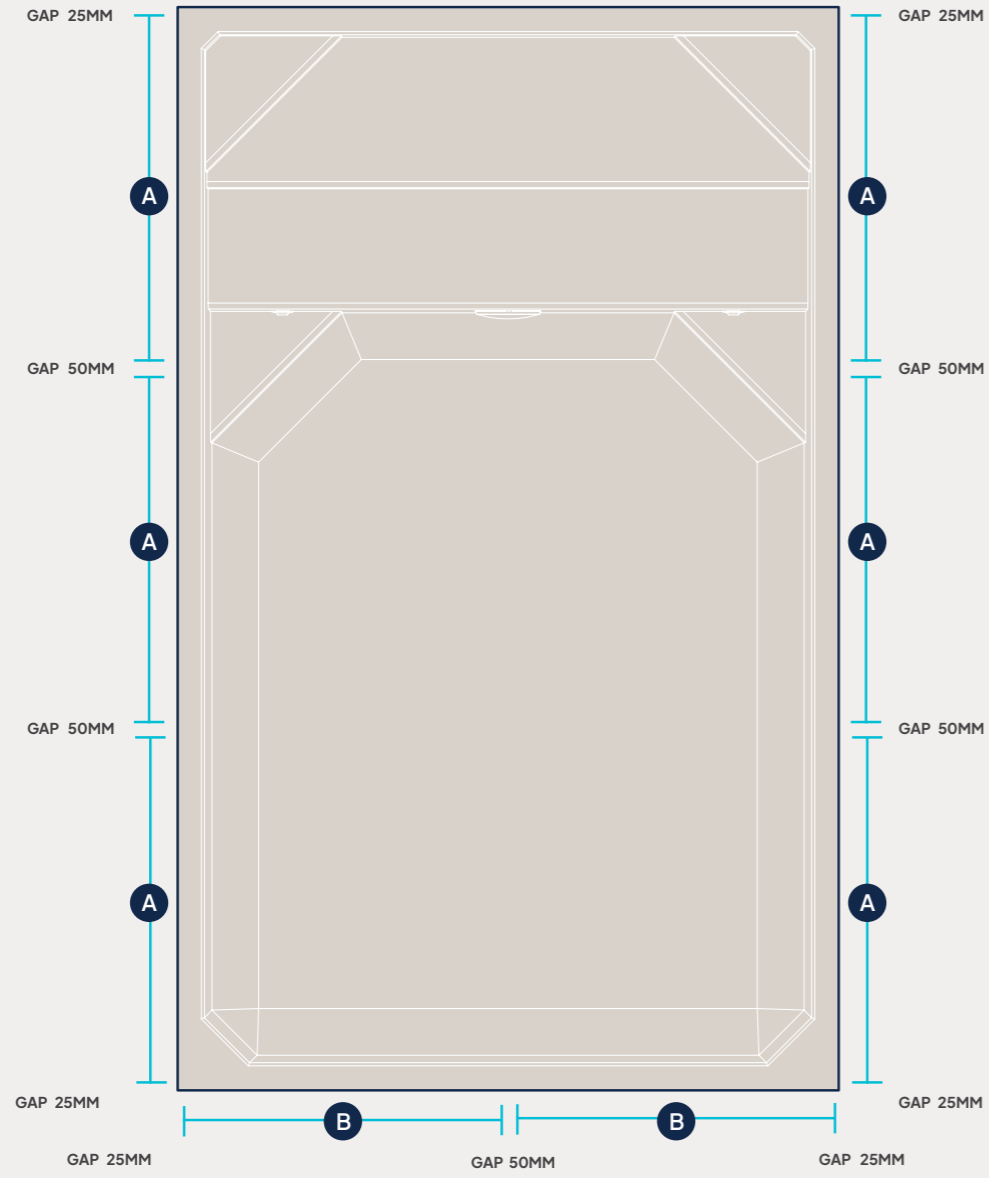

	A	B
Number of Panels	6	2
Panel width (mm)	1150	1050
Panel height (mm) - Recommended	1460	1460
Final panel height above pool (mm)	1260	1260
Mounting Pins Required (Per side)	18	12

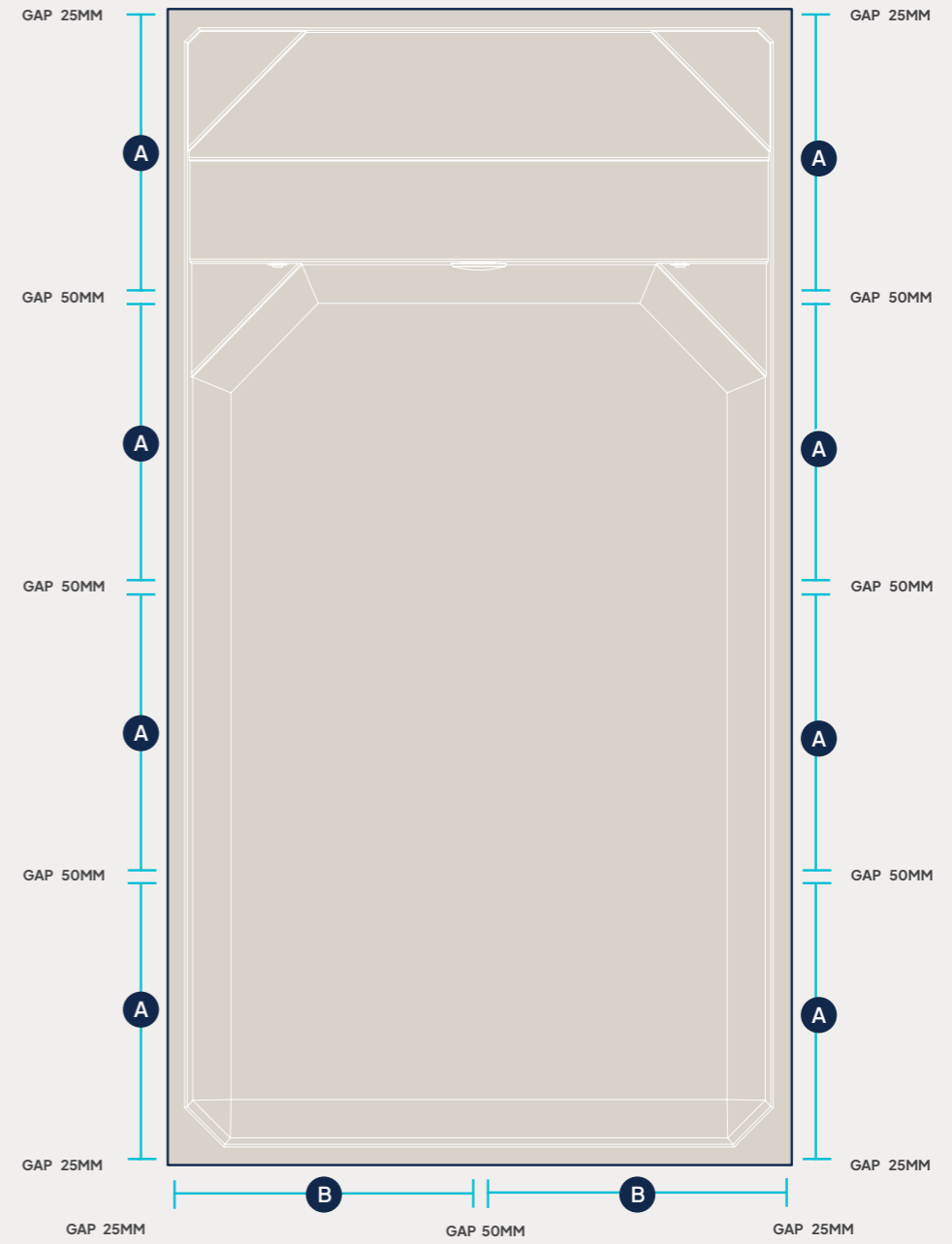

	A	B
Number of Panels	8	2
Panel width (mm)	1100	1200
Panel height (mm) - Recommended	1460	1460
Final panel height above pool (mm)	1260	1260
Mounting Pins Required (Per side)	24	12

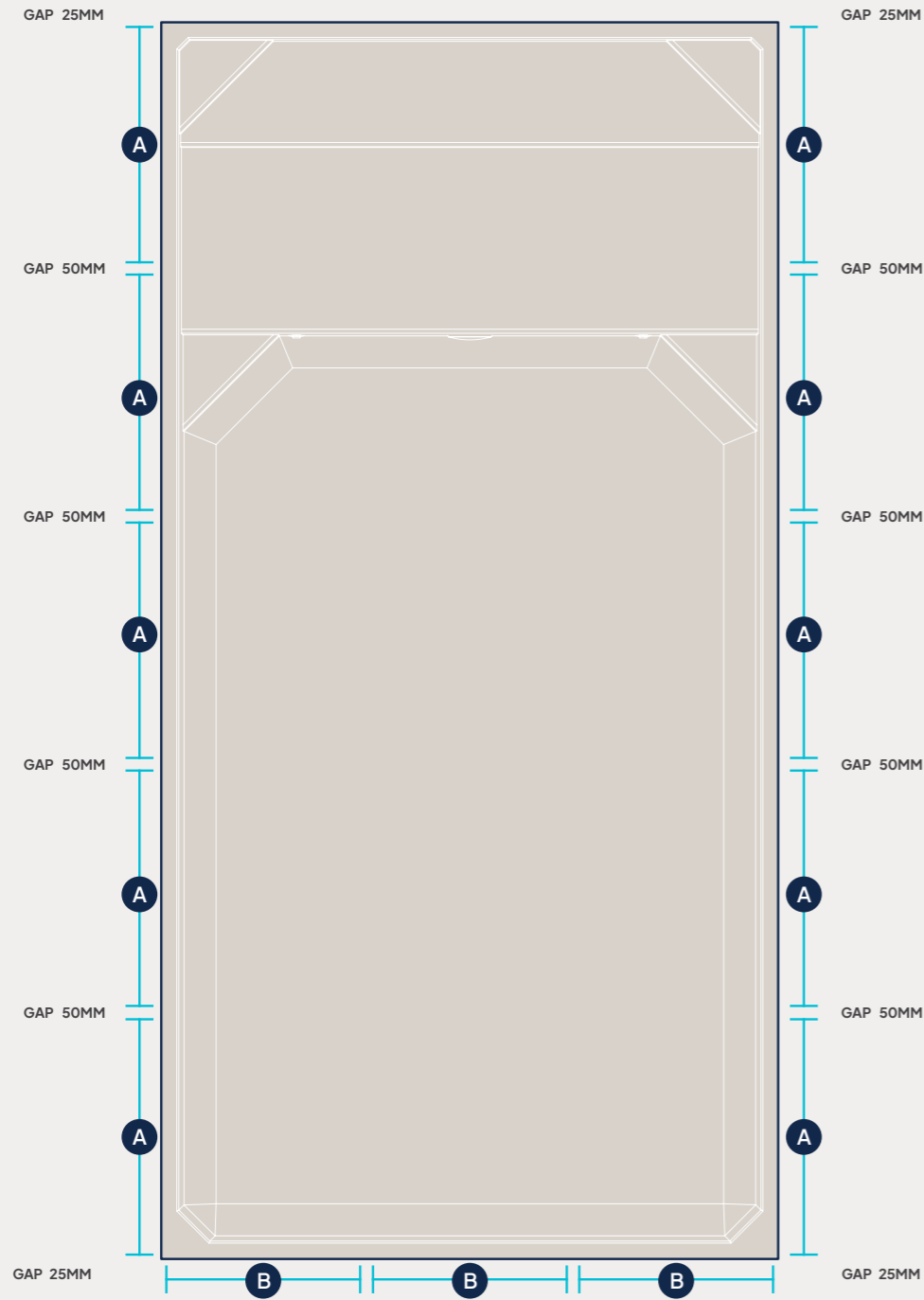

	A	B
Number of Panels	10	3
Panel width (mm)	1150	950
Panel height (mm) - Recommended	1460	1460
Final panel height above pool (mm)	1260	1260
Mounting Pins Required (Per side)	30	18

Tiling requirements

When purchasing a Plungie as a blank shell, meaning without our standard ecoFinish internal coating, the Plungie will require waterproofing in-field before the internal tile finish can be carried out.

We recommend engaging a trade qualified tiler who has experience waterproofing and tiling concrete pools as this is a critical step in finishing the internal of the Plungie.

The below recommendations have been put forward by Living Style Landscapes as a general guide to assist in scoping your project.

HIDE SKIM LID

The Hide Skim solution allows you to replace your factory finish lid with a stainless steel lid that has an inlay allowing you to drop in your surrounding tile or decking board for a seamless finish.

Supplier	Reece Plumbing
Product Code	1536728
Size	342mm Hide Skimmer Lid Kit Inlay 15–22mm

WATERPROOFING THE SHELL

Product	Laticrete Hydro Ban
Coats	Two
Application	As per product direction Further information on Laticrete Hydro Ban can be found here.

GLUING + GROUTING LARGE FORMAT TILES

Glue	Laticrete 335 Further information on Laticrete 335 can be found here.
Grout	Mapei Keracolor FF Further information on Mapei Kercolour FF can be found here.

GLUING + GROUTING SMALL MOSAIC TILES

Glue	Mapei Keracolor FF in selected grout colour mixed with Mapei Liquid additive (mix turns grout to glue).
Grout	Mapei Keracolor FF in selected grout colour mixed with water, as per product description. Further information on Mapei Kercolour FF can be found here.

Waterline Tile Provision

When selecting ecoFinish, a provision can be made for the ecoFinish to stop at the bottom of the skimmer entry. This will allow you to apply a waterline tile to your pool once installed.

The location for the waterline is approximately 200mm ±5mm from the top of the pool, with our ecoFinish stopping slightly above the first corner step.

!
Important:
 The provision for the waterline tile needs to be confirmed prior to production of the pool.

PLUNGIE ARENA

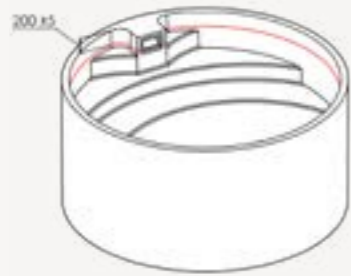

PLUNGIE STUDIO

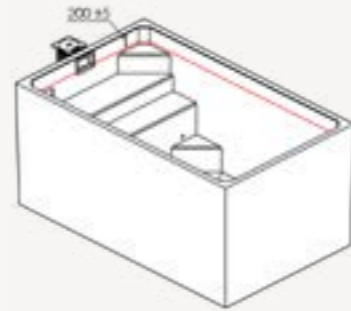

PLUNGIE ORIGINAL

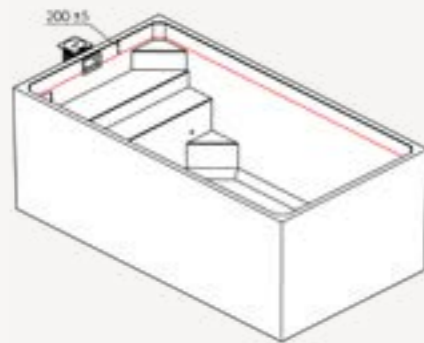

PLUNGIE MAX

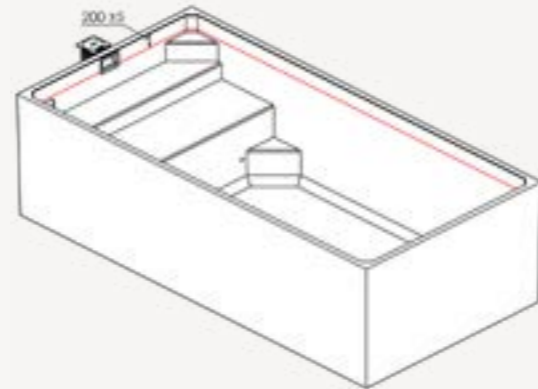

Top Edge ecoFinish

If you would like the ecoFinish to continue over the top edge of the Plungie please contact our team.

Note - this must be specified at time of order.

Coping Tiles

We recommend The Pool Tile Company who have a range of coping tiles specific to Plungie's measurements.

PLUNGIE ARENA

- 3.5m diameter
- Mosaic Edge Recommended

PLUNGIE STUDIO

- 3.6m x 2.2m
- 28pce Coping
- 4pce Diagonal Corners

PLUNGIE ORIGINAL

- 4.6m x 2.5m
- 35pce Coping
- 4pce Diagonal Corners

PLUNGIE MAX

- 6m x 3m
- 46pce Coping
- 4pce Diagonal Corners

COPING DETAILS

All items are non-stocked and custom made to order - lead times apply.

Coping quantities are calculated on pool lineal meters with 10% wastage - some on-site cutting is required

EXTERNAL OVERHANG:

5mm to allow for render, mosaics, or cladding on exposed external shells.

INTERNAL OVERHANG:

5-10mm, to allow for +/- 5mm shell manufacture variance.

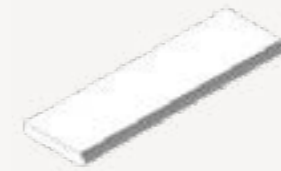

Coping Tiles
 Shaded edge is Profile Edge



Diagonal Internal Corners
 Shaded edge is Profile Edge

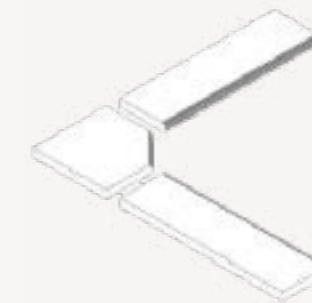

Tiling Guide for Corners
 Shaded edge is Profile Edge

PROFILE EDGE OPTIONS

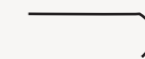

Machine Bullnose

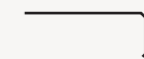

Machine Square

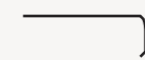

Tumbled

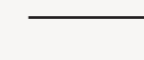

Natural Travertine



www.plungie.com
1300 PLUNGIE (758 644)